

Thank you for choosing SWIT products. Please read the instructions before using, and keep it for future reference.

Introduction

This product is designed and apply to use in film, TV, photography and studio lighting, also can be used in theater, concert or other entertainment stage lighting.

Specification

Model	CL-60D	CL-120D
LED	900pcs	1800pcs
Color Temperature	2700K-6500K	
Intensity	0%-100%	
Illuminance	2000 Lux@1m	3700 Lux@1m
	250 Lux@3m	470 Lux@3m
	100 Lux@5m	180 Lux@5m
Half beam angle	About 65°	
Beam angle	About 100°	
Half beam angle (with honey comb)	About 40°	About 45°
CRI	95	
TLCI	99	
Working Voltage	DC 11V-17V	
Output power	Appr. 60W	Appr. 120W
Energy Efficiency Index	<G> Test under this parameter: Dimmer=100%, CCT=6500k	
Dimensions	See Fig.1 /Fig.2 /Fig.3	
Luminous size	310mm x 310mm	600mm x 310mm
Weight	3.2Kg	4.7Kg

Cautions

1. Do not disassemble the panel light or touch the interior with metal objects to prevent damaging the equipment.
2. Do not store the panel light in dusty or wet environment to avoid damage.
3. In order to ensure safety, please use the safety rope when hoisting the lamp.
4. Working temperature is between -10°C and 40°C.

Maintenance

1. Please clean the front LED panel soft cloth with slight clean neutral detergent solution please wipe again with a soft dry cloth.
2. Do not use wet cloth, anhydrous alcohol, gasoline or a mixture of anhydrous alcohol and ether etc. to wipe the front LED panel.

Overall dimension

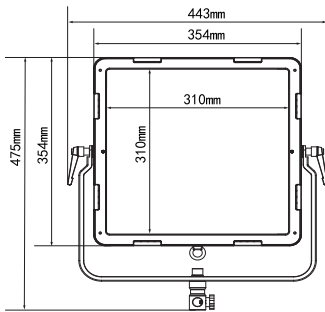

Fig.1 CL-60D



Fig.2 CL-60D/CL-120D

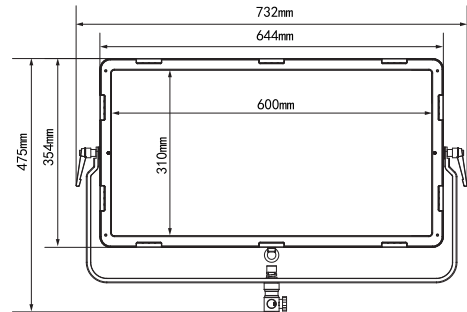

Fig.3 CL-120D

Appearance

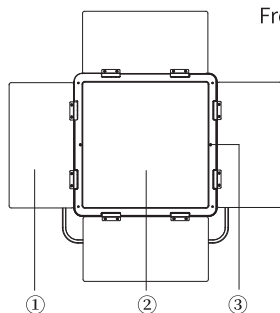

Fig.4 CL-60D

Front view

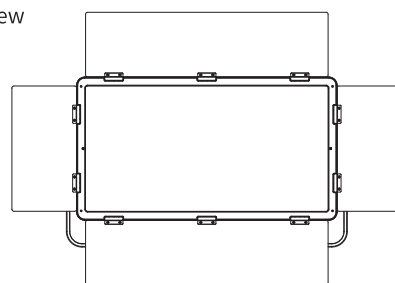

Fig.5 CL-120D

Rear view

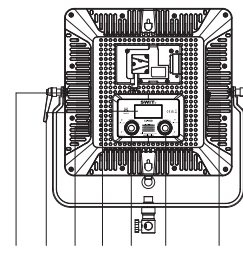

Fig.6 CL-60D

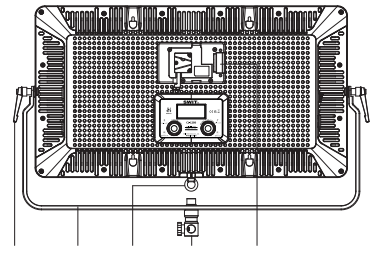

Fig.7 CL-120D

- ① Barn door
- ② Diffuser
- ③ Mounting hole

- ④ DMX OUT
- ⑤ USB interface
- ⑥ DMX IN
- ⑦ LCD screen
- ⑧ Intensity
- ⑨ Color temp
- ⑩ DC input
- ⑪ Power switch
- ⑫ Adjust knob
- ⑬ U-shape bracket
- ⑭ Ring
- ⑮ Bracket adaptor
- ⑯ Battery plate

LCD display information

Take the "color temperature 5600 k, brightness 100%, battery full power supply, DMX communication mode, communication address 008" as an example:

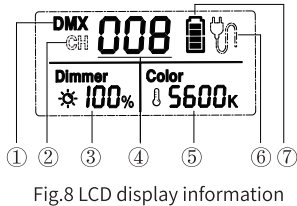

- ① Current Support Communication Control Mode for Light - DMX Communication Mode
- ② Communication control mode currently supported by light - Inter control mode between lamps and lanterns
- ③ Brightness display
- ④ Communication address
- ⑤ Color temperature
- ⑥ Power supply display (Adaptor)
- ⑦ Power supply display (Battery)

The power display when using battery:

Four cells	About 80%-100%
Three cells	About 60%-80%
Two cells	About 40%-60%
One cells	About 20%-40%
Blank	Below 20%, Power warning

Accessories

Fig.9~Fig.10 shown as how to assembly the honeycomb, CL-60D is the same as CL-120D.

- ① M3*16 Screws
- ② Honeycomb

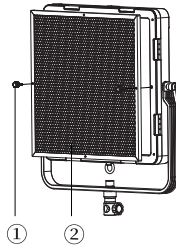

Fig.9 Honeycomb assembly

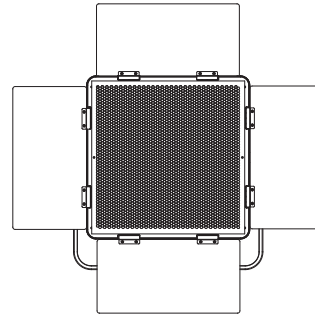

Fig.10 Honeycomb and barn door

Usage

1. Install

1.1 Accessories

Honeycomb (fig.9, fig.10) installation method detailed see [Accessories]

- Install this product on the light bracket according to the requirement of use, adjust the illumination angle of light through adjustable handle.

2. Power supply

This product support battery and adaptor power supply, switch on the light (Fig.6 ⑩), set the require light parameter by brightness adjusting knob (Fig.6 ⑧), color temperature adjusting knob (Fig.6 ⑨), then use normally.

Tips: The connection and disconnection of power adaptor XLR.

- Connection
Align the hump of output male XLR to the gap of the DC socket, connect XLR and DC socket, the adaptor will connect with the light when you hear the crack sound.
- Disconnection
Hold the hump of the DC output female XLR and pull out, the power adaptor and the light will be disconnected.

3. Setting and Use of Brightness and Color Temperature

This product support two color temperature and brightness adjusting mode: General adjusting mode. Fast adjusting mode. Press brightness/color temperature adjusting knob (Fig.6 ⑧/⑨) to change the adjusting mode the user can set the brightness/color temperature quickly by combining the two adjustment modes according to the usage demand.

3.1 General adjusting mode

- Color temperature adjusting
Range: 2700K-6500K, adjusting step length: 50K

- Brightness adjusting
Range: 0%-100%, adjusting step length: 1%

3.2 Fast adjusting mode

- Color temperature adjusting
In this mode, you can quickly select common color temperature: 2700K, 3200K, 4500K, 5600K, 6500K
- Brightness adjusting
Range: 0%-100%, adjusting step length: 10%

4. Setting and Use of Communication Address

Long pressing the brightness adjusting button (Fig.6 ⑧) about 2s to enter in communication address setting interface, communication address range: 001-512.

LCD digital tube field (Fig.8 ④) flashing indicates that the current bit is selected, rotate the brightness adjustment knob (Fig.6 ⑧) to

set the current bit, press the brightness adjustment knob (Fig.6 ⑧) to determine the setting of the current bit and go to the next bit, when the setting of the last bit is completed, press the brightness adjustment knob (Fig.6 ⑧) or wait for about 5 s, to exit the setting of the communication address.

5. Setting and Use of Communication Control Mode

Through the DMX line of the lamp network, long press color temperature adjustment knob (Fig.6 ⑨) about 2 s, to complete the lamp communication control mode setting.

5.1. DMX communication model.

LCD upper left corner shows "DMX" (Fig.8 ①) indicates that the current supported communication control mode of the light is DMX communication mode. in this mode, the DMX signal output equipment is connected to the lamp network, and the communication address is set up, which can be used normally. One panel light takes up 2 DMX control channels. The current set DMX address (N) is the brightness control, and the next set address (N+1) is the color temperature control.

For example:

DMX Communication address	DMX Control channel	Function
005	005	Brightness 0%-100%
	006	Color temperature 2700K-6500K

5.2. Intercontrol Mode

LCD upper left corner shows "CH" (Fig.8 ②) indicates that the communication control mode currently supported by the light is mutual control mode. In this working mode, the target lamp can be set to the same communication address for normal use without distinguishing between master and slave.

Attention: when using the mutual control function of lamps and lanterns, do not connect the output equipment of DMX signal in the network of lamps and lanterns, otherwise this function can not be used normally;

6. USB interface usage

USB interface is reserved interface, please use according to the designated environment of the company's related products, can not be used for other purposes, so as not to cause losses.

Packing list

Number	Details	Portable bag
1	CL-60D/CL-120D	x 1
2	Power cable	x 1
3	Warranty card	x 1
4	Light bag	x 1
5	User manual	x 1
6	Adaptor	x 1
7	V-mount fastener velcro	X1(CL-60D)
8	Ring (Optional)	X1(CL-120D)
9	Safety rope (Optional)	X2(CL-120D)
10	DMX cable (Optional)	Customers can purchase separately on demand
11	Honeycom (Optional)	

Tips: The adaptor and LED PCB board can be changed , the parameters of recommend adaptor are below:

No.	Specification	Parameter
1	DC output socket	4Pin XLR
2	Adapter output power polarity	Pin 1"-",Pin 4"+"
3	Working voltage	AC 100-240V, 50/60Hz
4	Output voltage	DC 12-17V
5	Voltage accuracy	±5%
6	Rated Power (Max.)	≥64.93W(CL-60D) ≥150W(CL-120D)
7	Power factor	≥0.9
8	Working temperature	-10°C-40°C