

**SWIT®**

**CL-M100C**  
 100W RGB Mini Size  
 Studio SMD LED Light  
 Ver:C

# USER MANUAL

## SWIT Electronics Co.,Ltd.

Tel:+86-25-85805753  
 Fax:+86-25-85805296  
<http://www.swit.cc>  
 E-mail: contact@swit.cc

Thank you for choosing SWIT products. Please read the instructions before using, and keep it for future reference.

### Specification

<b>Model</b>	<b>CL-M100C</b>	
LED QTY	RGB LED (170pcs) +Warm White LED(340pcs)	
White Light	Color Temperature	2800K-10000K, Minimum Adjust Step:50K
	Brightness	0%-100%, Minimum Adjust Step:0.1%
	Illumination	3000 Lux@1m 360 Lux@3m 140 Lux@5m
	CRI	96 Max. , Avg 94
	TLCI	93 Max. , Avg 90
RGB Light	RGB+W, Color Gamut, HUE, Saturability adjustment	
G-M Offset	Continuous adjustment (-1.00~+1.00, Adjust step 0.01)	
Half Beam Angle	About 62°	
Mode	CCT, HSI, RGB, CIE, GEL, EFF, DMX, SYS	
Control	Button, DMX, APP	
Update	USB: (Format "FAT" or "FAT32")	
Power	Power Consumption	About 100W
	Power Supply	AC 100-240V , 50/60HZ
Dimension	luminous Surface (L*W)	245mm x 146mm
	Full Light(L*W*H)	See Fig.1 & 2
Weight	5.1Kg	

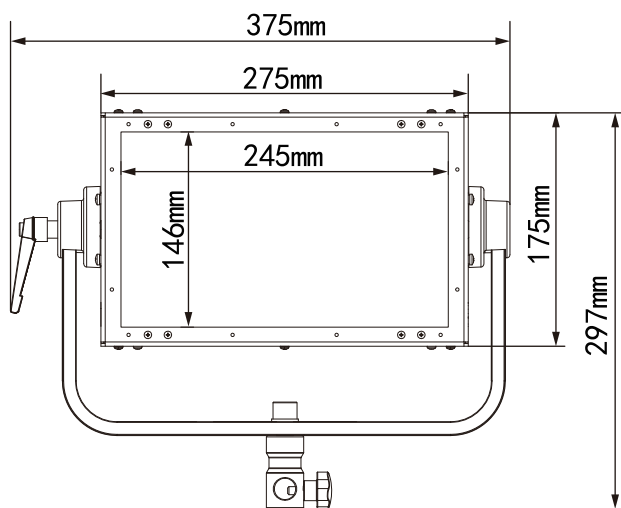

Fig.1 CL-M100C Front View

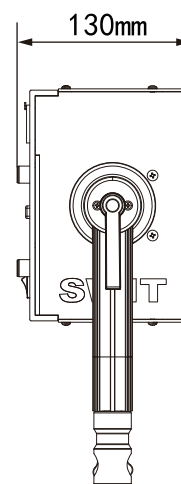

Fig.2 CL-M100C Side View

### Warning

1. Do not disassemble the panel light or touch the interior with metal objects to prevent damaging the equipment.
2. Do not store the panel light in dusty or wet environment to avoid damage.
3. In order to ensure safety, please use the safety rope when hoisting the lamp.
4. Working temperature is between -10°C and 40°C.

## Maintenance

1. Please clean the front LED panel with soft dry cloth. If using soft cloth with slight clean neutral detergent solution, please wipe again with a soft dry cloth.
2. Do not use wet cloth, anhydrous alcohol, gasoline or a mixture of anhydrous alcohol and ether etc. to wipe the front LED panel.

## Appearance

### 1. Front View:

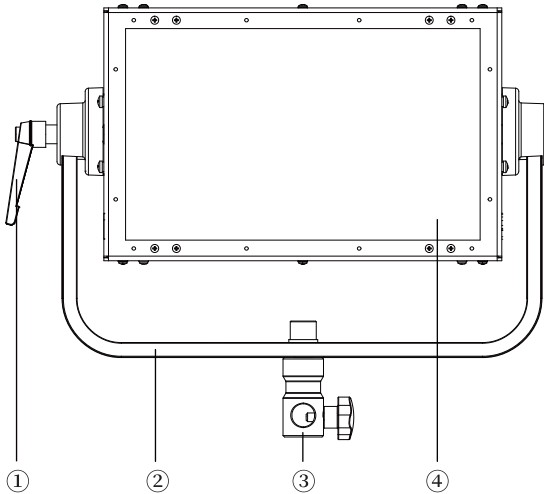

Fig.3 CL-M100C Front View

### 2. Back View

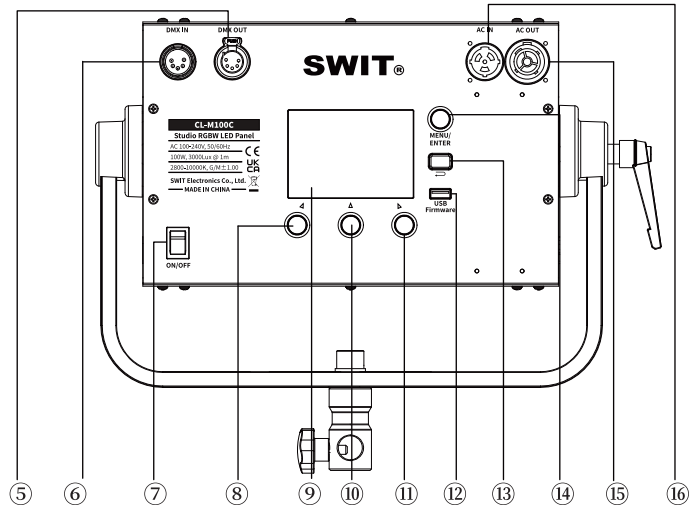

Fig.4 CL-M100C Back View

- |                       |                |               |                     |
|-----------------------|----------------|---------------|---------------------|
| ① YOKE TILT LOCK KNOB | ⑤ DMX OUT      | ⑨ LCD         | ⑬ "BACK" BUTTON     |
| ② U SHAPE BRACKET     | ⑥ DMX IN       | ⑩ ADJUST KNOB | ⑭ MENU/ENTER BUTTON |
| ③ STAND ADAPTOR       | ⑦ POWER ON/OFF | ⑪ ADJUST KNOB | ⑮ AC OUT            |
| ④ DIFFUSER            | ⑧ ADJUST KNOB  | ⑫ USB         | ⑯ AC IN             |

## Installation of safety rope

When lifting and using the lamps, please pass the safety rope (hereafter referred to as "safety rope") through the lamp wire hole and the round tube of the barn door according to the method shown in Fig. 5, so as to establish an effective connection between the product and the hanging devices such as hinges.

### Precautions for use of safety rope are as follows:

- 1) If you use your own safety rope, please confirm that the load of the safety rope is greater than that of this product;
- 2) The safety rope cannot be dragged on the rough surface;
- 3) Please check carefully before using the safety rope, where the rope strand is broken or the number of broken wires in one twist distance exceeds 6, the safety rope shall not be used. The safety rope with obvious wear, corrosion, deformation and damage caused by heat or arc is not allowed to use;
- 4) The safety rope is strictly prohibited from contact with any charged body, hot object or flame;
- 5) The two safety rope buckles shall not be directly connected with each other, and D shackle in accordance with the load specifications must be added.

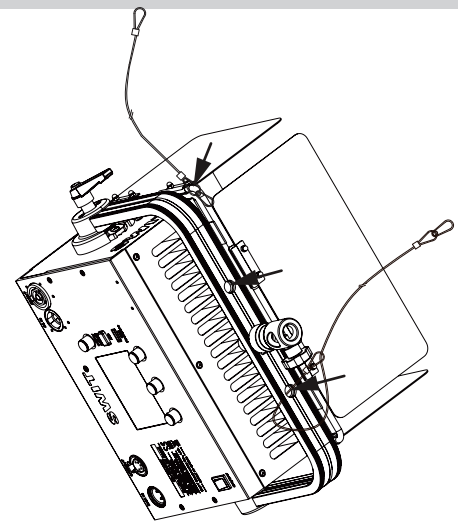

Fig.5 Installation diagram of safety rope

## User control

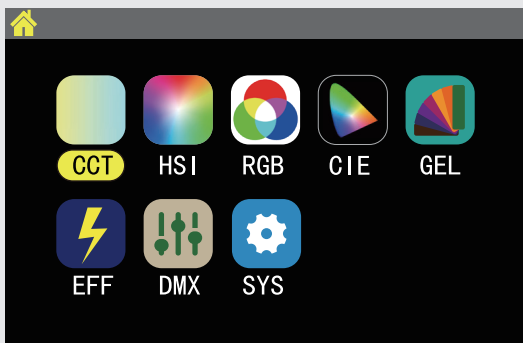

Fig.6 Main Menu

No.	Menu List	No.	Menu List
1	CCT Mode	5	GEL Mode
2	HSI Mode	6	EFF Mode
3	RGB Mode	7	DMX Mode
4	CIE Mode	8	SYSTEM

Form 1 Menu List

### When the light is working:

- ▶ user can return back to Menu via "⏪" button (Fig.4 ⑬);
- ▶ Use "ADJUST KNOB" (Fig.4 ⑧⑩⑪) to select different mode;
- ▶ Use "MENU/ENTER" (Fig.4 ⑭) to enter different mode.

### 1. CCT Mode

In this mode, user can adjust "CT", "G/M", "I" via "ADJUST KNOB"

Fig.4 ⑧⑩⑪

No.	Parameter	Adjustment Step	Minimum Step
1	CT(Color Temp)	2800K-10000K	50K
2	G/M	-1.00← +0.00→+1.00	0.01
3	I(Intensity)	0%-100%	0.1%

Form.2 【CCT Mode】

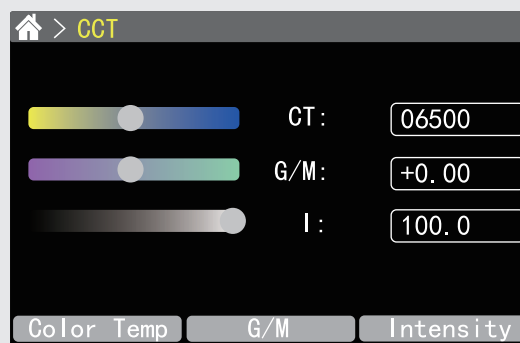

Fig.7 CCT Mode

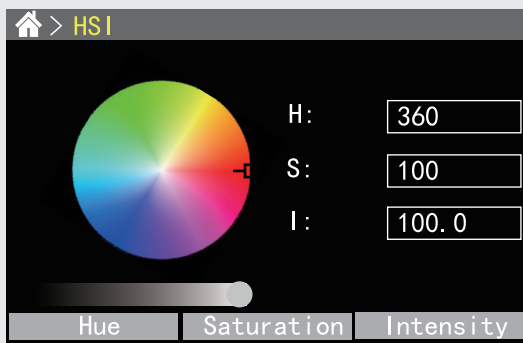

Fig.8 HSI Mode

### 2. HSI Mode

In this mode, user can adjust "H", "S", "I" via "ADJUST KNOB" Fig.4

⑧⑩⑪

No.	Parameter	Adjustment Step	Minimum Step
1	H(Hue)	1°-360°	1°
2	S(Saturation)	0%-100%	1%
3	I(Intensity)	0%-100%	0.1%

Form.3 【HSI Mode】

### 3. RGB Mode

In this mode, user can adjust "R", "G", "B" via "ADJUST KNOB" Fig.4

⑧⑩⑪

No.	Parameter	Adjustment Step	Minimum Step
1	R(Red)	000-255	1
2	G(Green)	000-255	1
3	B(Blue)	000-255	1

Form.4 【RGB Mode】

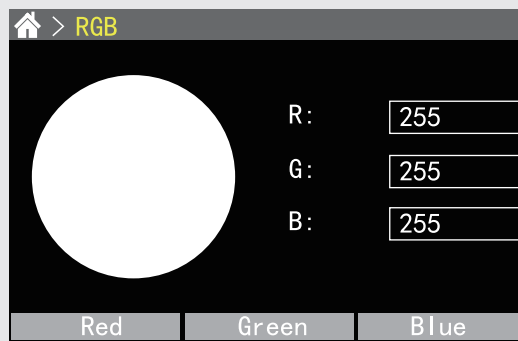

Fig.9 RGB Mode

## 4.CIE Mode

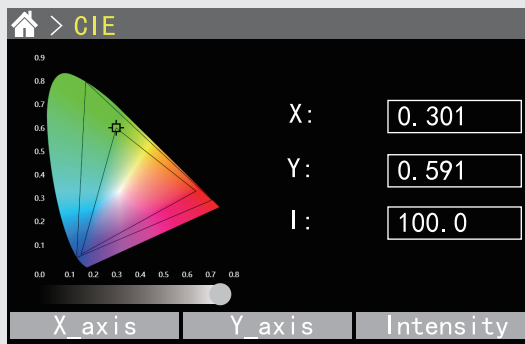

Fig.10 CIE Mode

In this mode, User can adjust "X", "Y", "I" via "ADJUST KNOB" Fig.4 (8)/(10)/(11)

No.	Parameter	Adjustment Step	Minimum Step
1	X_axis	0.131-0.708	0.001
2	Y_axis	0.046-0.797	0.001
3	I(Intensity)	0%-100%	0.1%

Form.5 【CIE Mode】

## 5.GEL Mode

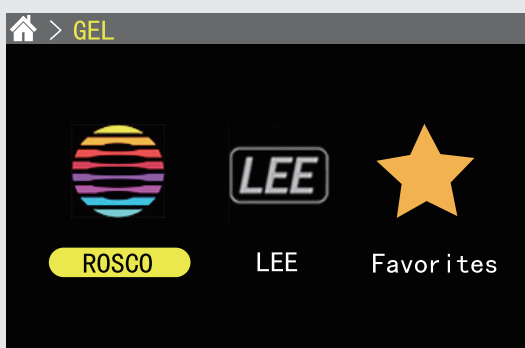

Fig.11 GEL Mode



Fig.12 GEL Mode (ROSCO)

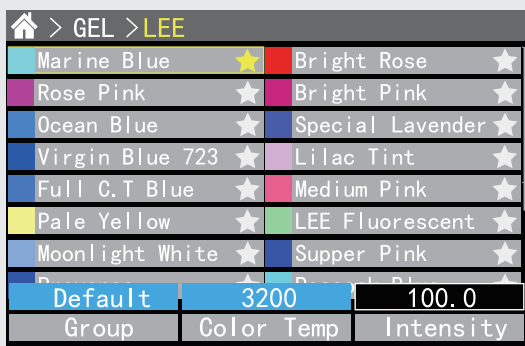

Fig.13 GEL Mode (LEE)

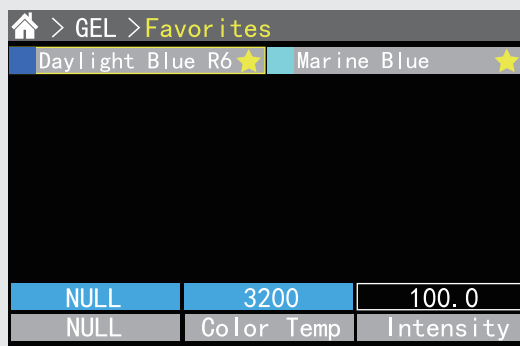

Fig.14 GEL Mode (Favorites)

User can choose different filters and adjust the "Intensity", "Color Temp" in this mode:

### 1) "MENU/ENTER"

- ▶ Rotate: To choose different selection
- ▶ Press: Enter into ROSCO/LEE/favorites, put the filters into your favorites.

### 2) "ADJUST KNOB": Fig.4 (8)(10)(11), to adjust different parameters.

No.	Selection	Adjustment
1	ROSCO	1.20 kinds of Filters 2.Color temperature from 3200K to 5600K 3.Intensity:0%-100%, Minimum steps:0.1%
2	LEE	1.20 kinds of Filters 2.Color temperature from 3200K to 5600K 3.Intensity:0%-100%, Minimum steps:0.1%
3	Favorites	1.Color temperature from 3200K to 5600K 2.Intensity:0%-100%, Minimum steps:0.1%

Form.6 【GEL Mode】

## 6.Effect Mode

User can choose from 12 kinds of effect in this mode “COPCAR”、  
“CANDLE”、“FIREWORK”、“TELEVISION”、“LIGHTNING”、“PAPARAZ-  
ZI”、“PARTY”、“BROKEN LIGHTS”、“EXPLODE”、“NEON LIGHT”、“FIRE” and  
“COLORCYCLE”.

In this mode, User can select different Effect via "MENU/ENTER" button  
(Fig.4 ⑭), adjust "Speed"、"Intensity" via “ADJUST KNOB” Fig.4 ⑧⑩⑪.

No.	Parameter	Adjustment Step	Minimum Step
1	Effect	COPCAR, FIREWORKS Etc.	/
2	Speed	1-10	1
3	Intensity	0%-100%	0.1%

Form.7 【Effect Mode】

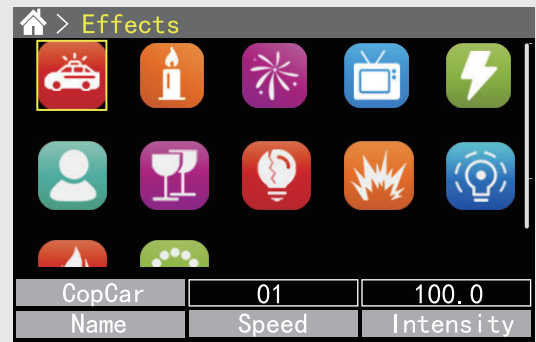

Fig.15 EFF Mode

## 7.DMX Mode

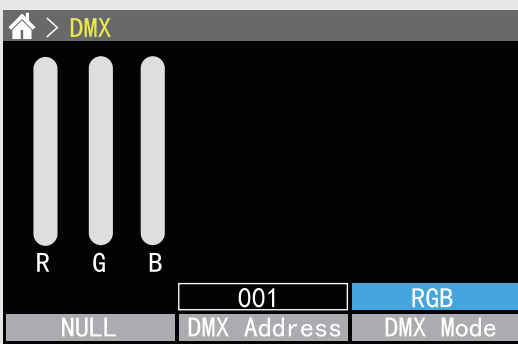

Fig.16 DMX Mode

User need to switch on DMX function in “SYS”-“DMX ON/OFF”,  
then user can adjust “DMX Address”, “DMX Mode” via “ADJUST KNOB”  
Fig.4 ⑧⑩⑪

No.	Parameter	Adjustment Step	Minimum Step
1	DMX Address	001-512	001
2	DMX Mode	CCT、HSI、RGB、CIE、 CCT&HSI、CCT&CIE、 CCT&RGB	/

Form.8 【DMX Mode】

### 7.1 DMX Address and DMX Mode

The DMX address and DMX Mode can be set in the following two ways:

- 1) Set in "DMX mode"(Fig.22);
- 2) Set in "SYS"- "DMX Address"/"DMX Mode".

### 7.2 DMX Channel Setting

DMX address adjustment range:001-512, suppose the current address is N:

No.	DMX Mode	Channel	Definition
1	CCT	N	Intensity:0%-100%
		N+1	Color Temperature:2800K-10000K
		N+2	G/M:-1.00→+1.00
2	HSI	N	Intensity:0%-100%
		N+1	Hue:1°-360°
		N+2	Saturation:0%-100%
3	RGB	N	Red:0-255
		N+1	Green:0-255
		N+2	Blue:0-255
4	CIE	N	Intensity:0%-100%
		N+1	X_axis:0.131-0.708
		N+2	Y_axis:0.046-0.797
5	CCT&HSI	N	Intensity:0%-100%
		N+1	Color Temperature:2800K-10000K
		N+2	G/M:-1.00→+1.00
		N+3	Mode Change (CCT→HSI)
		N+4	Hue:1°-360°
		N+5	Saturation:0-100%
6	CCT&CIE	N	Intensity:0%-100%
		N+1	Color Temperature:2800K-10000K
		N+2	G/M:-1.00→+1.00
		N+3	Mode Change (CCT→CIE)
		N+4	X_axis:0.131-0.708
		N+5	Y_axis:0.046-0.797
7	CCT&RGB	N	Intensity:0%-100%
		N+1	Color Temperature:2800K-10000K
		N+2	G/M:-1.00→+1.00
		N+3	Mode Change (CCT→RGB)
		N+4	Red:0-255
		N+5	Green:0-255
		N+6	Blue:0-255

Form.9 【DMX Mode】DMX

## 8. SYS(System)

Select【SYS】, press MENU/ENTER to enter into the sub menu:

SYS	
Firmware Version	V0.0.9R
Hardware Number	4011000006
BlueTooth Name	CL-M100C-45578
BlueTooth Reset	<input checked="" type="checkbox"/> YES
Update	<input checked="" type="checkbox"/> YES
Flip ON/OFF	<input type="checkbox"/>
DMX ON/OFF	<input checked="" type="checkbox"/>

Fig.17 System

### 8.1 **【Firmware Version】&【Hardware Number】**

Show the information of the version of the device.

### 8.2 **【Bluetooth Name】**

User can rename the Bluetooth of the device via “MENU/ENTER” button.

### 8.3 **【Bluetooth Reset】**

In the process of using the APP to control the lamp, if the APP loses control or the target lamp cannot be found, the user can choose to try to reset the target lamp.

The bluetooth reset steps is as follows:

Choose**【Bluetooth Reset】-【Yes】** to reset the bluetooth.

### 8.4 **Update**

Prepare the update firmware and U-disk (Make sure the format of U-disk is :FAT32) , connect U-disk with USB port of the light, Choose**【Update】-【Yes】**,after updating, reboot your light to finish the updating.

**Tips: The firmware needs to be saved into the root of the U-disk.**

### 8.5 **LCD Flip**

Choose**【Flip ON/OFF】**to switch ON/OFF screen flip function.

### 8.6 **DMX Mode**

Choose**【DMX ON/OFF】**to switch ON/OFF DMX function.

### 8.7 **DMX Address**

Choose**【DMX Address】**to set DMX address from 001-512.

### 8.8 **DMX Mode**

Choose**【DMX ON/OFF】**to select from different DMX Mode.

### 8.9 **Light Curve**

Choose**【Light Curve】**to select from different Light Curve.

### 8.10 **Language**

Choose**【Language】**to change language to Chinese or English, reboot your light after choosing the language.

### 8.11 **EFF File Import**

Put the Effect files in your U-disk, choose**【EFF File Import】**,select the Effect files you want to import, choose-**【yes】** to import the Effect files.

**Tips: Make sure the Effect files you saved is in the U-Disk CL-M100C**

### 8.12 **GEL File Import**

Put the GEL files in your U-disk, choose**【GEL File Import】**,select the GEL files you want to import, choose-**【yes】** to import the GEL files.

**Tips: Make sure the filters files you saved is in the U-Disk CL-M100C**

### 8.13 **EFF File Delete**

Choose**【EFF File Delete】**, select the Effect files you want to delete, choose**【Yes】** to delete the Effect files.

### 8.14 **GEL File Delete**

Choose**【GEL File Delete】**, select the GEL files you want to delete, choose**【Yes】** to delete the GEL files.

### 8.15 **All Files Import**

User can Import all Effect files and GEL files from the U-disk via this function:

Choose**【All Files Import】-【Yes】** to import all Effect and GEL files from your U-disk to the light.

### 8.16 **Factory Reset**

User can do factory reset to reset Bluetooth and Userdata.

### 8.17 **Factory Menu**

Not available to users.

## APP

### 1. APP name and download

1) Name: SWIT Console

2) Download

Android: Scan QR to Install(Fig.18);

IOS: Apple Store



Fig.18 Android APP

## Packing list

No.	Details	Quantities
1	CL-M100C	x 1
2	AC Power Cable	x 1
3	Safety Rope	x 2
4	AC Loop out Cable	Optional